

# Coral Sea C-2

## Never underestimate your fresh water needs

Sea Recovery creates the perfect watermaker for large yachts by combining industrial-strength production with space saving designs. Coral Sea systems are not only installed in luxury yachts, but are also regularly found on oil rigs and commercial vessels around the world. The system's durable construction is the reason why it easily crosses over to both industries. The Coral Sea is also user friendly, featuring electronic monitoring, an LCD touchscreen, and the latest in watermaking technology.

\*Please refer to Sea Recovery's commercial brochure for larger systems.



### Coral Sea Key Features

- Large-volume production, small footprint
- User-friendly color touchscreen
- Radial axial pump does not need oil change
- Optional automatic Media Filter



Category | Mega Yachts (over 80 ft / 24 m)

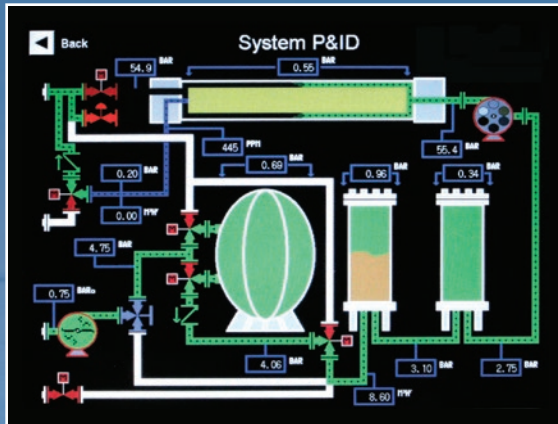

### Rugged and reliable operation

The Coral Sea uses industrial PLC that is specifically designed to perform heavy duty operations. All functions are displayed on to the LCD touch screen and/or remote, allowing users to monitor and control the system from any location on the boat. With the Coral Sea, boaters are able produce water at any time and any place.

### Functions that ensure your safety

The Coral Sea is one of the easiest and safest industrial grade watermakers to own. It features automatic operation and safety sensors, that when triggered, automatically shut down the system. To ensure safe operation, the Coral Sea will shut down when:

- pre-filter maintenance is required
- operating pressure limit is exceeded



Photo courtesy of Westport Yachts



The Coral Sea’s electronic meters also monitor important functions:

- fresh water flow
- brine discharge flow
- product water flow

### Convenient configuration and design

Sea Recovery’s membrane technology allows our watermakers to maximize the most space per gallon than any other systems on the market. The Coral Sea can produce up to 280 gallons an hour, and will fit in any large yacht with modular, horizontal, and vertical system configurations.

## Specifications - Coral Sea C-2

	Model	No. of Vessels	Vessel Size	Production / Hour	Production / 24 Hrs.	Weight
PRODUCTION & WEIGHT	2800	4	3"	699 gal / 442 lit	2,799 gal / 10.59 m3	980 lbs / 445 kg
	3600	4	3"	899 gal / 568 lit	3,599 gal / 13.62 m3	980 lbs / 445 kg
	4200	3	4"	1,050 gal / 662 lit	4,200 gal / 15.89 m3	980 lbs / 445 kg
	5200	4	4"	1,299 gal / 820 lit	5,199 gal / 19.68 m3	1000 lbs / 454 kg
	6200	5	4"	1,549 gal / 978 lit	6,199 gal / 23.46 m3	1020 lbs / 463 kg
	6800	6	4"	1,699 gal / 1,073 lit	6,799 gal / 25.73 m3	1050 lbs / 477 kg

### ELECTRICAL

Model 2800 - 3600			
Power	HP Pump	Booster	FLA
220/50 Hz/1PH	7.5	2	39
220/50 Hz/3 PH	7.5	2	27
230/60Hz/3PH	7.5	2	24
460/60Hz/3PH	7.5	2	12

Model 4200 - 6800			
Power	HP Pump	Booster	FLA
230/60Hz/1PH	N/A	N/A	N/A
208/60Hz/3PH	10	2	35
230/60Hz/3PH	10	2	31
460/60Hz/3PH	10	2	16

External Installation Water Connections	Feed Inlet	Clean Inlet	Brine Discharge	Clean Return	Product
2800 & 3600 ANSI Threaded Flange	3/4"	3/4"	3/4"	3/4"	1/2"
4200, 5200, 6200 & 6800 ANSI Threaded Flange	1"	1"	1"	1"	1/2"

# Dimensions

## Coral Sea C-2

VERTICAL

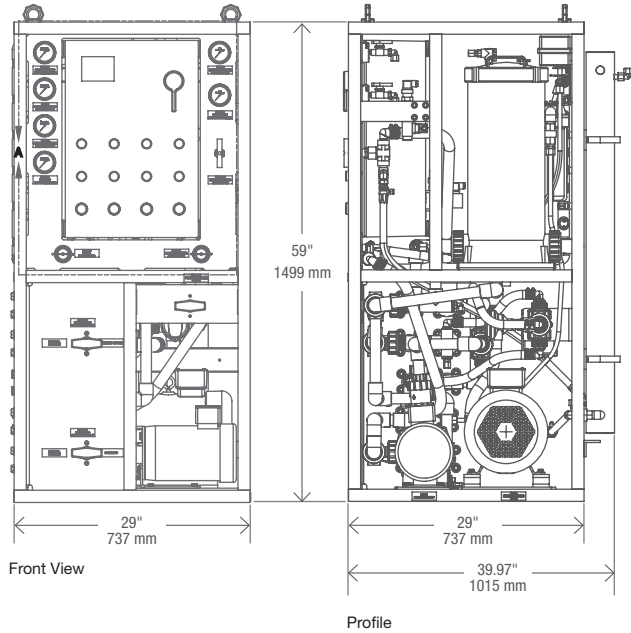

HORIZONTAL

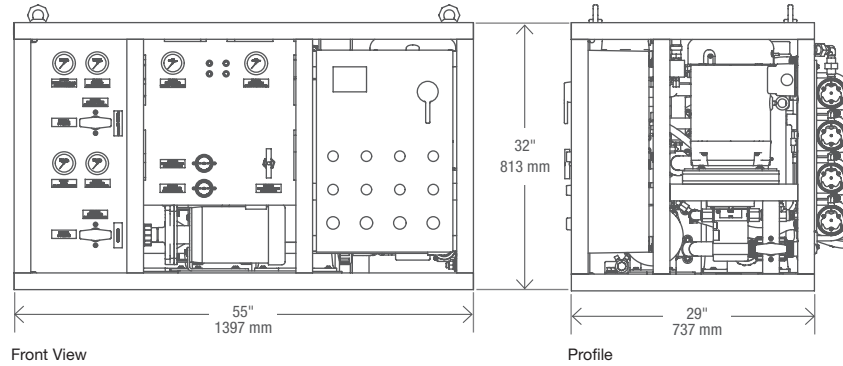

MODULAR

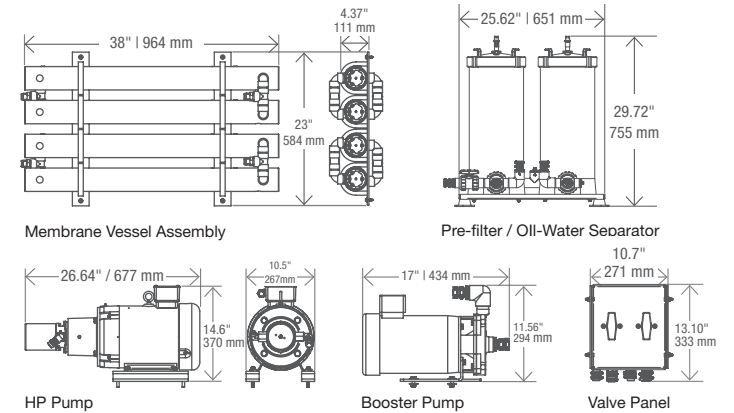
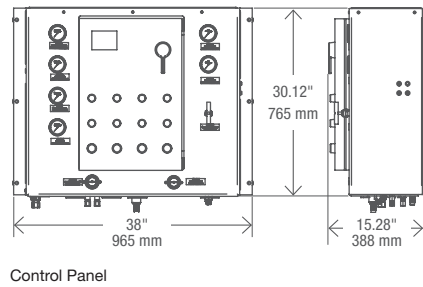

## Coral Sea C-2 Accessories



**UV Sterilizer**  
Eliminates 99.8 percent of bacteria and viruses from the feed water.



**Fresh Water Flush**  
Prolong membrane life at the touch of a button.



**Multi-Media Filter**  
Traps suspended solids larger than 30 microns to provide additional protection for the system's pre-filters, extending pre-filter element life. Please inquire for optional Automatic MMF



**Chemical Injection**  
Control the chemistry of the feed water to reduce and prevent fouling.



**pH Neutralizer**  
Provides pH neutralization of the reverse osmosis system product water.

\* Refer to your owner's manual or visit [www.searecovery.com](http://www.searecovery.com) for dimensions

# Marine Accessories

KEY: ■ Aqua Matic ■ Aqua Whisper DX/PRO ■ Aqua Mini ■ Ultra Whisper

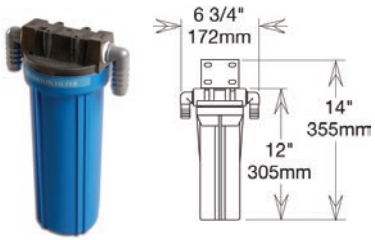

### Plankton Filter

Filters most microorganisms from the feed water, prolonging pre-filter life.

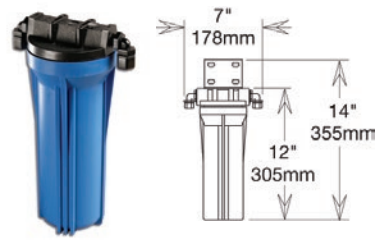

### pH Neutralizer

Brings R.O. product water to a neutral pH.

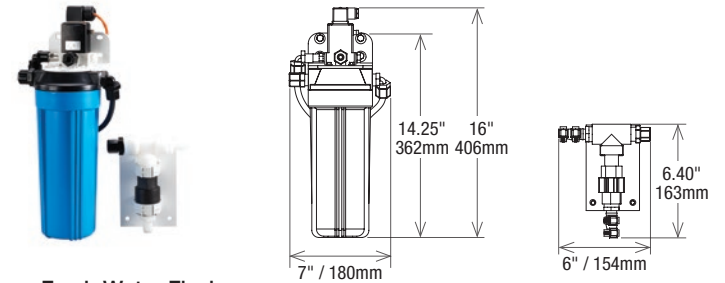

### Fresh Water Flush

Prevents fouling of the membranes and pre-filters by automatically rinsing the system with fresh water every seven days.

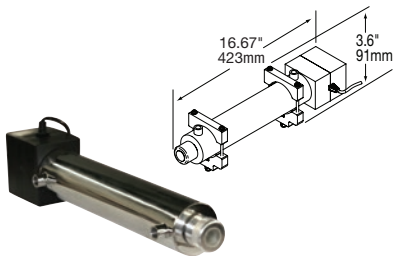

### UV Sterilizer

Eliminates 99.8% of bacteria, viruses and microorganisms from the feed water.

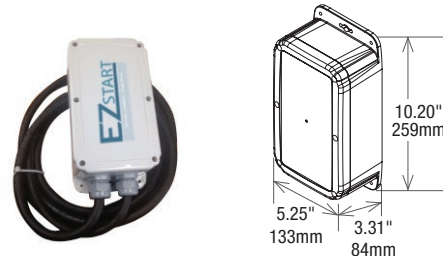

### Soft Motor Start

Reduces system start up, up to 50%. It is only available for single phase, 11-/220VAC, 50/60 Hz systems.

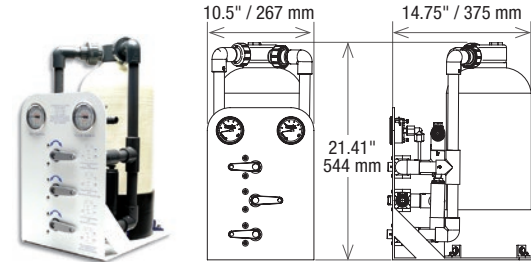

### Multimedia Filter

Reduces pre-filter changes. Saves time and money. Recommended where feed water is high in suspended particles and biological growth (plankton).



### Commercial Pre-filter & Oil / Water Separator

Recommended where feed water is high in suspended particles and biological growth (plankton).

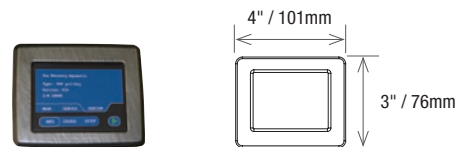

### Touch Screen Remote

Operate your system from any location.



### Push Button Remote

Operate your system from any location with this push button remote.



## Consumables and Spares



Use Sea Recovery's genuine replacement consumables and spares in order to provide your watermaker with the highest quality material. Ensure the quality of your fresh water production by replacing filter and membrane elements. Our cleaning and storage compounds help prolong your watermaker, and eliminate unnecessary buildup that can lead to extra maintenance. Contact your dealer to order spare replacements.

## All Sea Recovery Watermakers - General Specifications

### Product Water Production Stated Per Hour And Per Day Of Operation

Based in  $\pm 15\%$  at 800 psi / 55 Bar, 77°F / 25°C, 35,000 PPM TDS

### Salt Rejection (Chloride Ion)

99.4%

### Product Water Temperature

Ambient to feed water temperature

### Salinity Monitoring

Automatic computer controlled electronic monitoring with continuous readout in micromhos per cubic centimeter, are temperature compensated and of a fail-safe design.

### Salinity Range Of Feed Water

Seawater up to 50,000 PPM TDS (NaCl) (typically seawater salinity is 35,000 PPM TDS NaCl)

### Temperature Range

Max. 122°F / 50°C Min. 33° F / .5°C

### Reverse Osmosis Membrane

Specifically selected high rejection / high yield aromatic tri-polyamid, thin film composite, spiral wound, single pass reverse osmosis membrane element.

### Chlorine Tolerance

1000 hours @ 0.1 PPM, pH range 3-11

### Feed Water Pressure

Min 6 PSI / .42 Kg/cm<sup>2</sup> / 41.4kPa.

Max 40 PSI / 2.8 Kg/cm<sup>2</sup> / 275.8 kPa

### Operating Pressure

From seawater @ 35,000 PPM & 77°F

Nominal 800 pSI / 56.25 Kg/cm<sup>2</sup> / 5516 kPa

For more information on systems and features, visit: [www.searecovery.com](http://www.searecovery.com)



2630 E. El Presidio St., Carson, CA 90810  
Toll Free: (855) 339-6899 • Tel: (310) 608-5600  
Fax: (310) 608-5692 • Email: [waterpurification@parker.com](mailto:waterpurification@parker.com)  
Web: [www.searecovery.com](http://www.searecovery.com) | [www.parker.com/watermakers](http://www.parker.com/watermakers)

Authorized dealer in your area

Sea Recovery Corporation cannot accept responsibility for possible errors in catalogs, brochures and other printed material. Sea Recovery Corporation reserves the right to alter its products without notice. This also applies to products already on order provided that such alterations can be made without subsequential changes being necessary in specifications already agreed.

PN: D1SMB • SRC04062015